



**ASIAN UNIVERSITY
FOR WOMEN**

Request for Proposal of Construction of Boundary wall / Column construction work at Asian University for Women Arefin Nagar

RFP Summary Sheet

Name of the company	Asian University for Women
Procurement Reference Number	441/22-23
Date of issue of the RFP	27 th November, 2022
Date and Closing Time for RFP submission	13 th December, 2022 (12:01 pm) (GMT +6)
Quotation submission mail address	tender68@auw.edu.bd
Address for Communication	Asian University for Women 20/A M. M. Ali Road Chattogram 4000, Bangladesh Tel: +880-31-285-4980 Fax: +880-31-285-4988

Bidders are invited to submit their proposal in accordance with the enclosed Request for Proposal (RFP) terms.

AUW reserves the right to reject any or all offers without assigning any reason.

Complete confidentiality should be maintained. Information provided here should be used for its intended scope and purpose. Retention of this RFP signifies your agreement to treat the information as confidential.

All communication with regard to this request for proposal needs to be directed to AUW directly while in copy of all these communications at the email addresses mentioned in the RFP mail.

For any further queries can contact in below mail: Primary point of contact for RFP process and technical queries Mohammed Ishrat Bin Mahbub; Head of Procurement; Email: mohammed.mahbub@auw.edu.bd; Contact Number: +8801926673027; Whatsapp: +8801671470348.

Proposal should be submitted only in the email: **tender68@auw.edu.bd**

No other AUW email should be in TO/CC/BCC. Any proposal violate this instruction may face the cancellation of their proposal.

Objective

Asian University for Women (AUW) seeks to graduate women who will be skilled and innovative professionals, service-oriented leaders in the businesses and communities in which they will work and live, and promoters of intercultural understanding and sustainable human and economic development in Asia and throughout the world.

Requirements

We, to achieve our objectives, need the following product/services are below:

Construction of Boundary wall/Column Construction work

S.No.	Description	Unit	Quantity Required (Unit)	Unit Price	Total Price
Main Campus site Temple and lake city adjacent area's boundary wall / Column construction work request					
1	Boundary wall (Brick wall, RCC Footing, Column, Grade Beam and Cooping). Attached drawing /Design.	Rft	1700		
2	Boundary area Permanent RCC Pillar.10"x10"x6' feet above GL (Attached drawing). Including Plaster and Painting (Top 1 feet 2 coat enamel paint), writing work.	No's	37		
3	4feet wide and 7 feet height MS Gate.Supply, Installation Including painting and Notice writing	Sft	28		

Drawing and Design

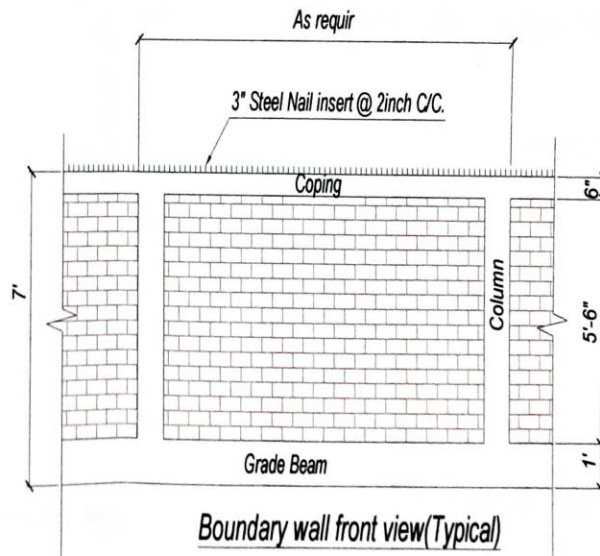
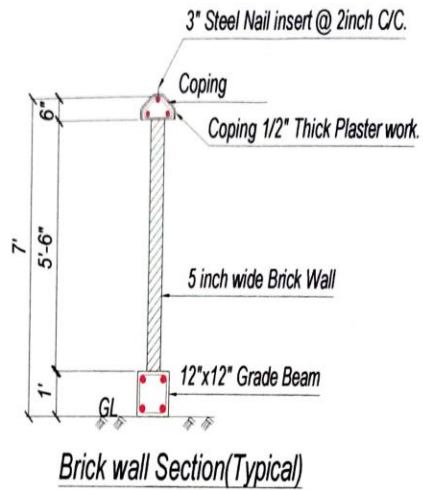
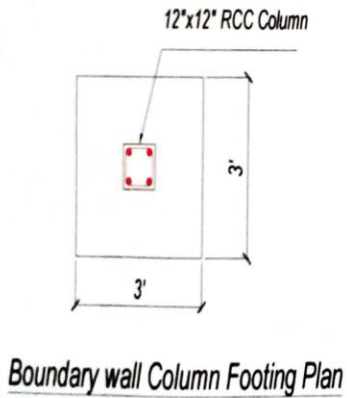
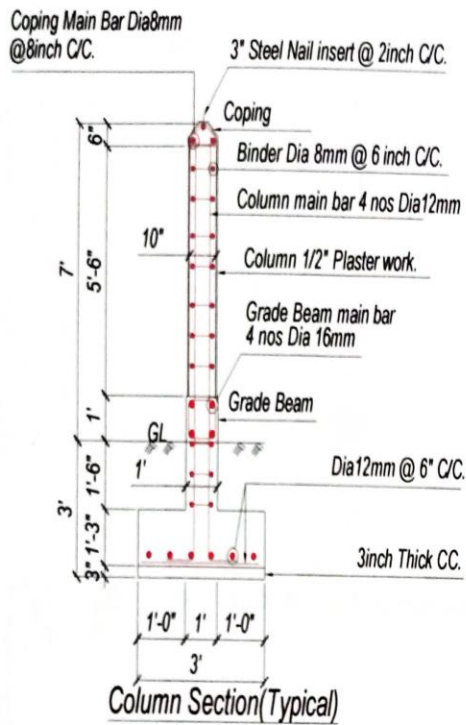

Boundary with Brick wall at Temple area plan.

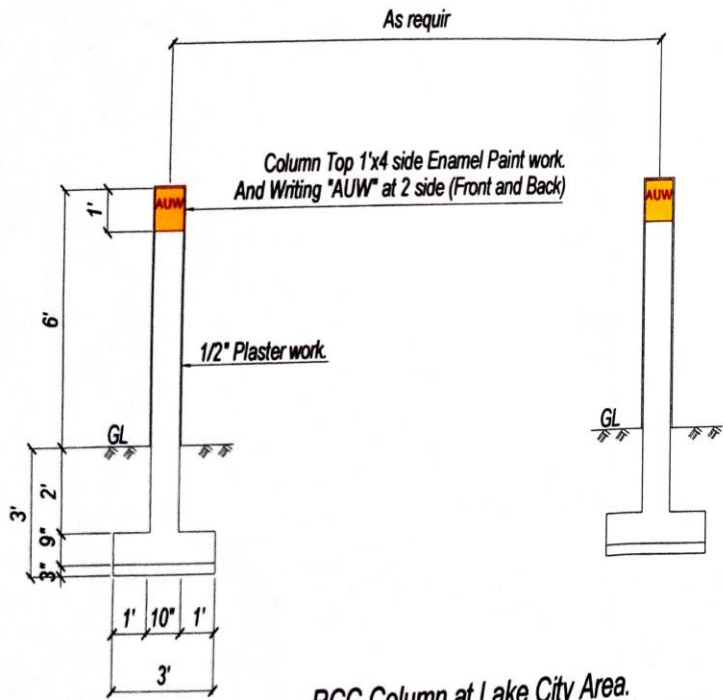

RCC Column at Lake City Area.

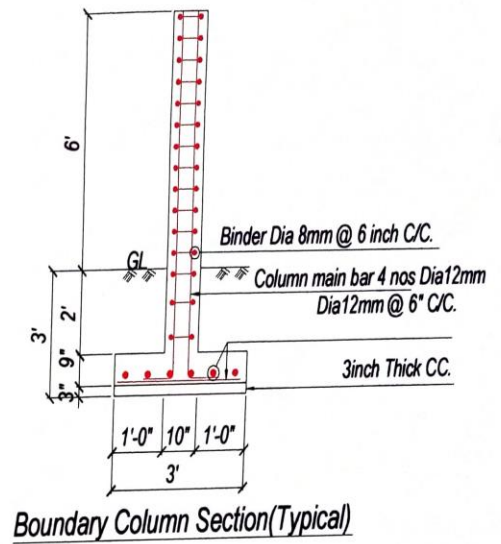

Boundary Column Section(Typical)

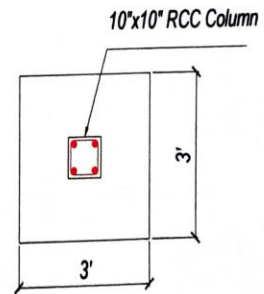

Boundary Column Plan

Boundary column at Lake city area detail.

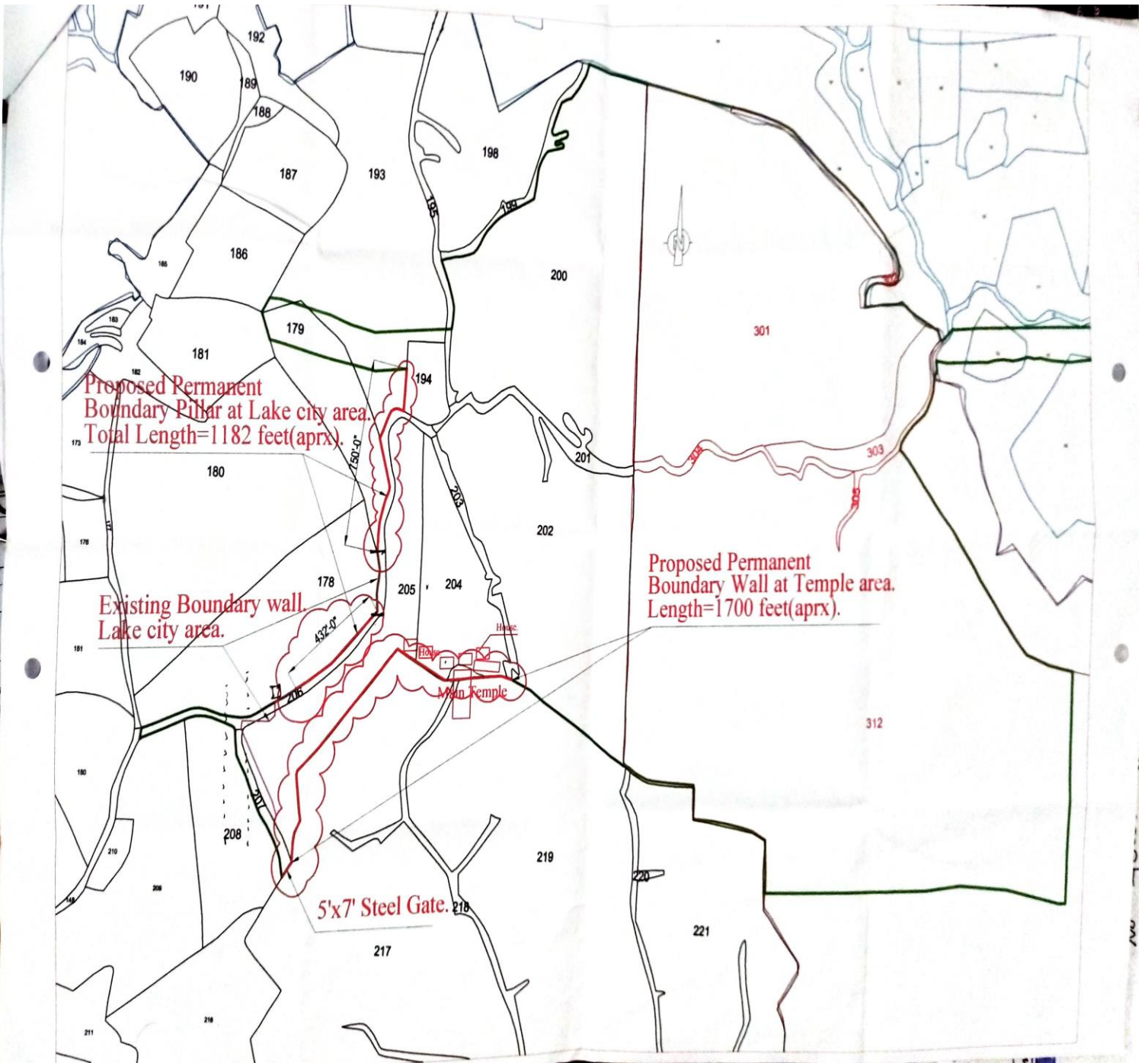

Information need to be submitted with financial proposals:

- a) Cost should mention VAT amount separately with percentage.
- b) Trade license
- c) TIN/BIN
- d) Similar work experience details
- e) Company details
- f) Lead time to accomplish the task

Please note that this offer is subject to the following terms and conditions:

1. The quantities mentioned are tentative quantities required and may change at the time of the finalization of the contract/PO.
2. The basic rates quoted should be effective until 10th July, 2023
3. AUW reserves the right to award the contract to one or more bidders. Accordingly, the final quantities required will be divided among successful bidders. The quantities so divided will be at the sole discretion of AUW.
4. AUW reserves the right to cancel the bidding before or after the receipt of bids or also after the opening of bids and call for fresh bids. AUW also has the right to reject any bid without assigning any reason.
5. Bids incomplete in any respect will not be considered.
6. Please mention your payment terms in the bid.
7. Any query for clarification on the bid can be had from the undersigned latest by 13th December, 2022 12:01 pm. Please note that any inquiry received from any bidder will be sent to all bidders without disc losing the source of the inquiry.